

PHE 1100TGHCOVER

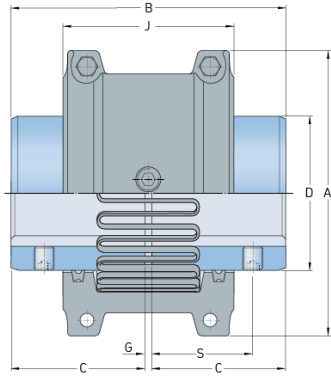

Size	1100
Nominal torque (lbft)	4631.89
Nominal torque (Nm)	6280
Min. bore (mm)	41
Max speed (r/min)	2440
Min. bore (in)	1.61
Max. bore (mm)	107
Max. bore (in)	4.21
Weight (kg)	4.6
Weight (lbs)	10.14