

PHC C2040X10FT

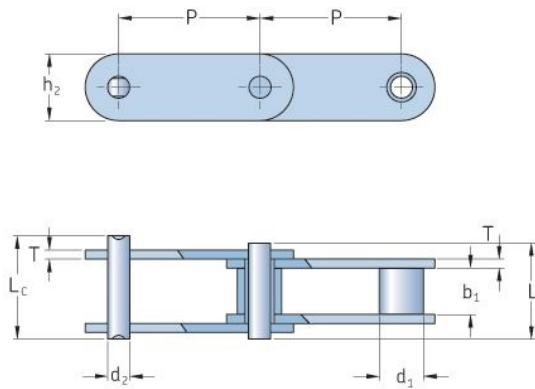

Pitch P (mm)	25.4
Pitch P (in)	1
Roller diameter d1 max (mm)	7.95
Roller diameter d1 max (in)	0.31
Width between inner plates b1 max (mm)	7.85
Width between inner plates b1 max (in)	0.31
Pin diameter d2 max (mm)	3.96
Pin diameter d2 max (in)	0.16
Plate height h2 max (mm)	12
Plate height h2 max (in)	0.47
Plate thickness T max (mm)	1.5
Plate thickness T max (in)	0.06
Weight (kg/m)	0.5
Weight (lbs/ft)	0.34