

PHS 25-1A60

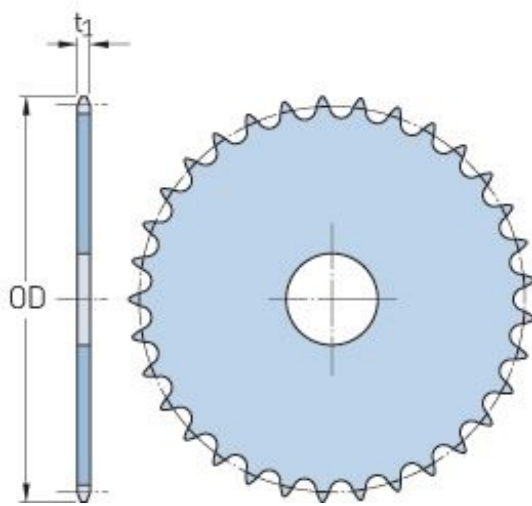

Pitch P (in)	0.25
No. of teeth	60
Diameter (in)	4.92
Min. bore (in)	-
Max. bore (in)	-
Hub H (in)	-
Hub L (in)	-
Weight (lbs)	0.54