

PHS 41-1A54

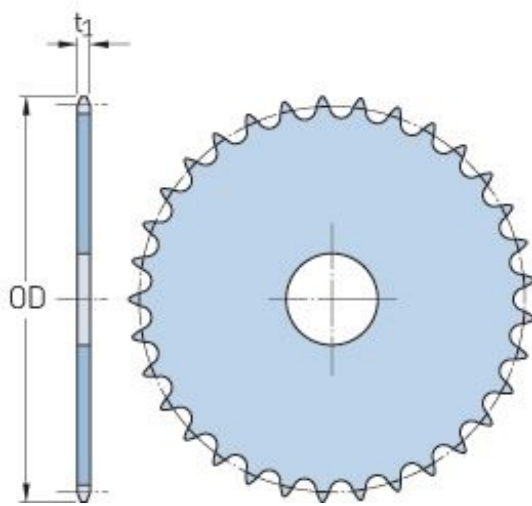

Pitch P (in)	0.5
No. of teeth	54
Diameter (in)	8.88
Min. bore (in)	-
Max. bore (in)	-
Hub H (in)	-
Hub L (in)	-
Weight (lbs)	3.54