

PHS 40-1B40

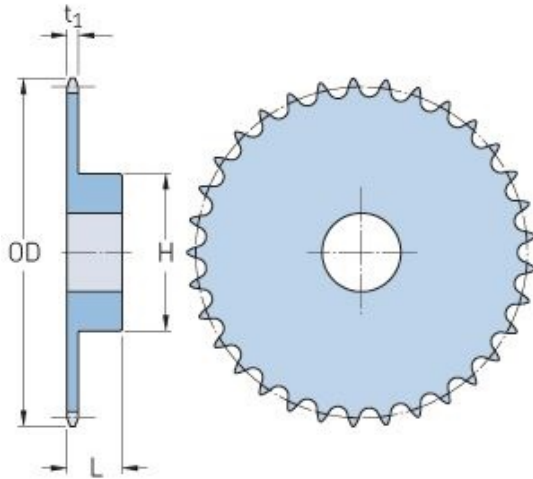

Pitch P (in)	0.5
No. of teeth	40
Diameter (in)	6.65
Min. bore (in)	0.75
Max. bore (in)	2.38
Hub H (in)	3.5
Hub L (in)	1.13
Weight (lbs)	4.69