

# PHS 50-1B37

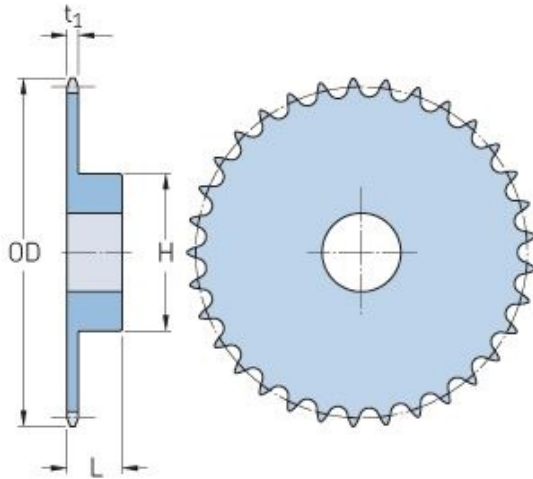

Pitch P (in)	0.63
No. of teeth	37
Diameter (in)	7.72
Min. bore (in)	0.75
Max. bore (in)	2.25
Hub H (in)	3.25
Hub L (in)	1.25
Weight (lbs)	5.9