

PHS 50-1A38

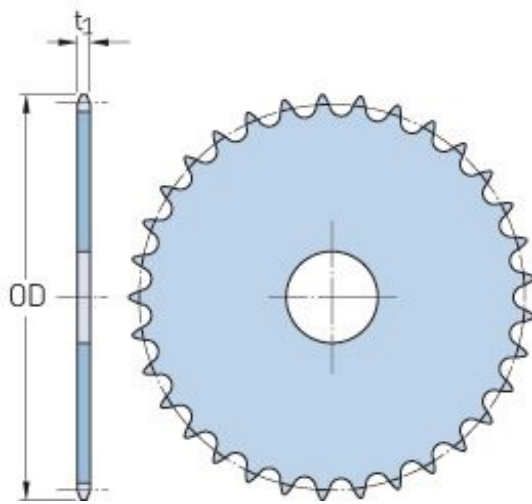

Pitch P (in)	0.63
No. of teeth	38
Diameter (in)	7.92
Min. bore (in)	-
Max. bore (in)	-
Hub H (in)	-
Hub L (in)	-
Weight (lbs)	4.14