

PHS 50-1A53

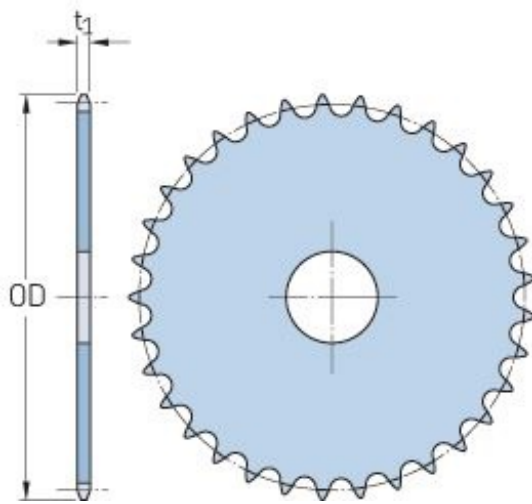

Pitch P (in)	0.63
No. of teeth	53
Diameter (in)	10.91
Min. bore (in)	-
Max. bore (in)	-
Hub H (in)	-
Hub L (in)	-
Weight (lbs)	8.08