

PHS 50-1A58

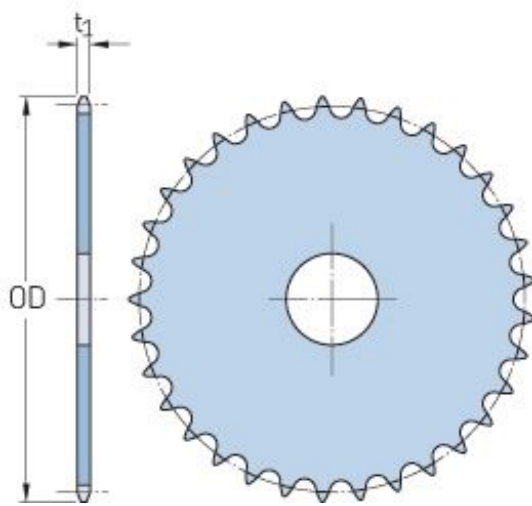

Pitch P (in)	0.63
No. of teeth	58
Diameter (in)	11.9
Min. bore (in)	-
Max. bore (in)	-
Hub H (in)	-
Hub L (in)	-
Weight (lbs)	10.3