

# PHS 60-1A41

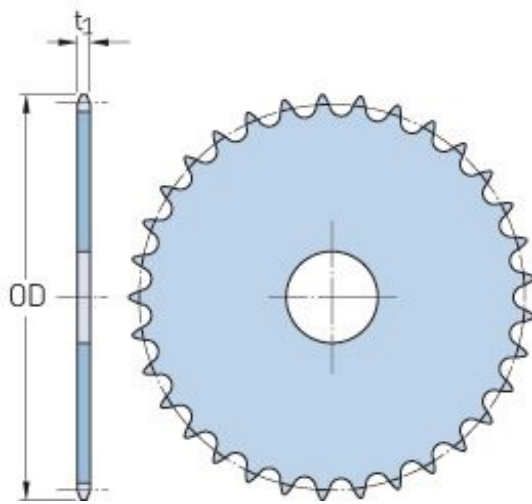

Pitch P (in)	0.75
No. of teeth	41
Diameter (in)	10.22
Min. bore (in)	-
Max. bore (in)	-
Hub H (in)	-
Hub L (in)	-
Weight (lbs)	9.1