

PHS 120-1A42

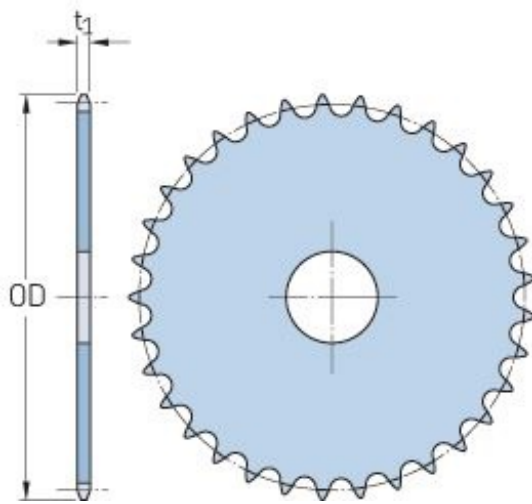

Pitch P (in)	1.5
No. of teeth	42
Diameter (in)	20.92
Min. bore (in)	-
Max. bore (in)	-
Hub H (in)	-
Hub L (in)	-
Weight (lbs)	75