

PHS 140-1B15

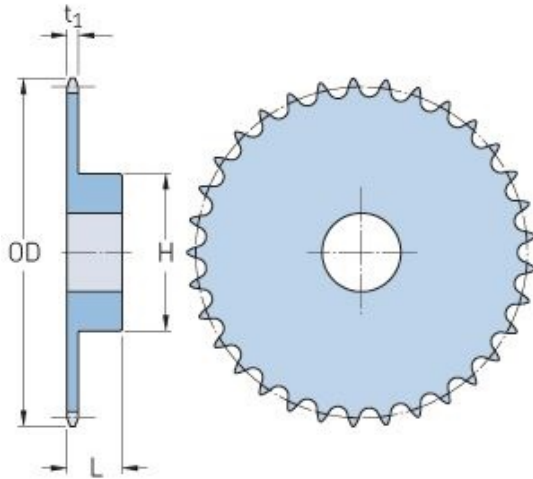

Pitch P (in)	1.75
No. of teeth	15
Diameter (in)	9.28
Min. bore (in)	1.5
Max. bore (in)	4.25
Hub H (in)	6.25
Hub L (in)	2.38
Weight (lbs)	25.1