

PHS 200-1A28

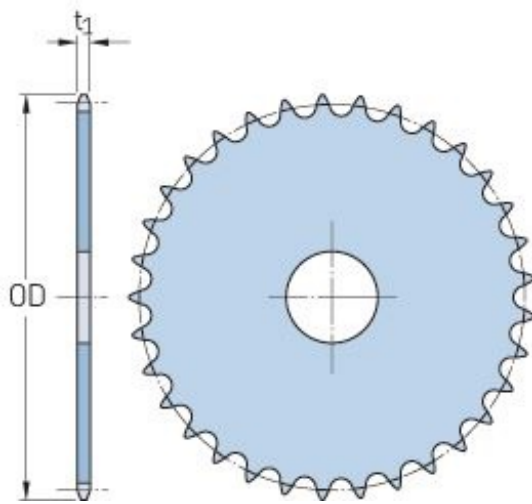

Pitch P (in)	2.5
No. of teeth	28
Diameter (in)	23.69
Min. bore (in)	-
Max. bore (in)	-
Hub H (in)	-
Hub L (in)	-
Weight (lbs)	144