

# PHS 200-1A30

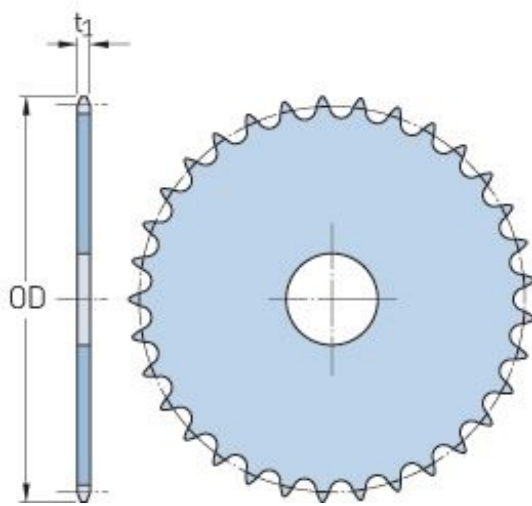

Pitch P (in)	2.5
No. of teeth	30
Diameter (in)	25.29
Min. bore (in)	-
Max. bore (in)	-
Hub H (in)	-
Hub L (in)	-
Weight (lbs)	167