

# PHS 06B-1B26

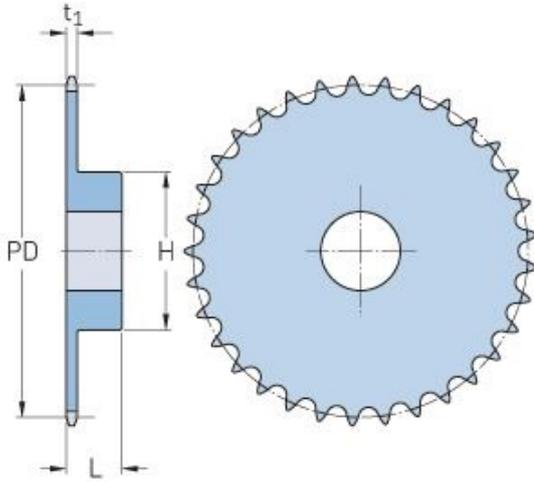

Pitch P (mm)	9.52
Pitch P (in)	0.37
No. of teeth	26
Pitch diameter (mm)	79.02
Pitch diameter (in)	3.11
Min. bore (mm)	12
Min. bore (in)	0.47
Max. bore (mm)	40
Max. bore (in)	1.57
Hub H (mm)	60
Hub H (in)	2.36
Hub L (mm)	28
Hub L (in)	1.1
Weight (kg)	0.67
Weight (lbs)	1.48