

# PHS 06B-1B33

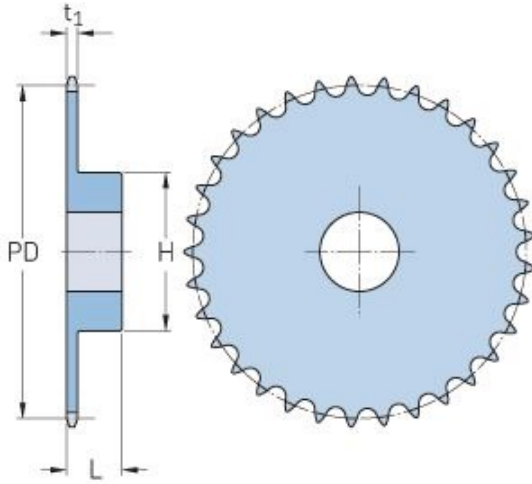

Pitch P (mm)	9.52
Pitch P (in)	0.37
No. of teeth	33
Pitch diameter (mm)	100.2
Pitch diameter (in)	3.94
Min. bore (mm)	14
Min. bore (in)	0.55
Max. bore (mm)	43
Max. bore (in)	1.69
Hub H (mm)	65
Hub H (in)	2.56
Hub L (mm)	30
Hub L (in)	1.18
Weight (kg)	0.91
Weight (lbs)	2.01