

PHS 06B-1B36

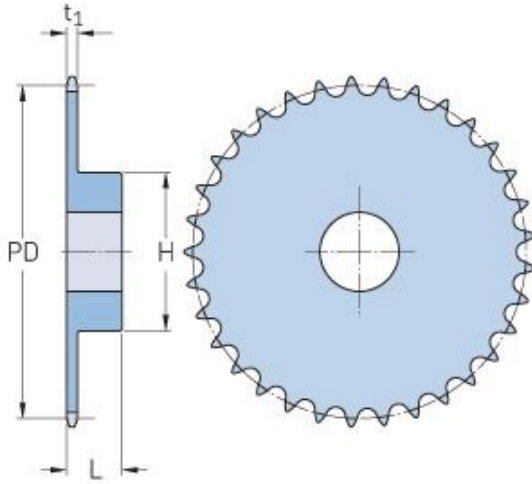

Pitch P (mm)	9.52
Pitch P (in)	0.37
No. of teeth	36
Pitch diameter (mm)	109.29
Pitch diameter (in)	4.3
Min. bore (mm)	14
Min. bore (in)	0.55
Max. bore (mm)	48
Max. bore (in)	1.89
Hub H (mm)	70
Hub H (in)	2.76
Hub L (mm)	30
Hub L (in)	1.18
Weight (kg)	1.07
Weight (lbs)	2.36