

PHS 06B-1A15

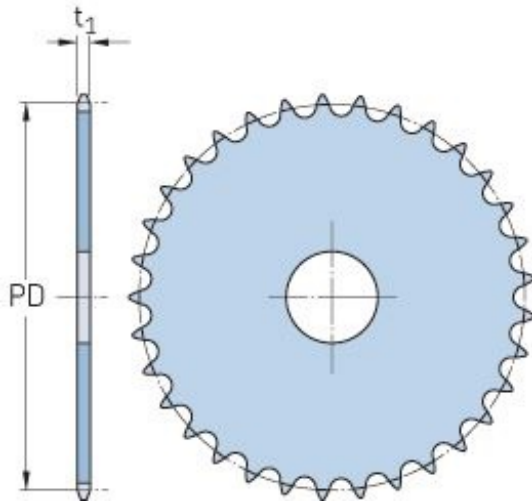

Pitch P (mm)	9.52
Pitch P (in)	0.37
No. of teeth	15
Pitch diameter (mm)	45.81
Pitch diameter (in)	1.8
Min. bore (mm)	-
Min. bore (in)	-
Max. bore (mm)	-
Max. bore (in)	-
Hub H (mm)	-
Hub H (in)	-
Hub L (mm)	-
Hub L (in)	-
Weight (kg)	0.06
Weight (lbs)	0.13