

# PHS 06B-1A42

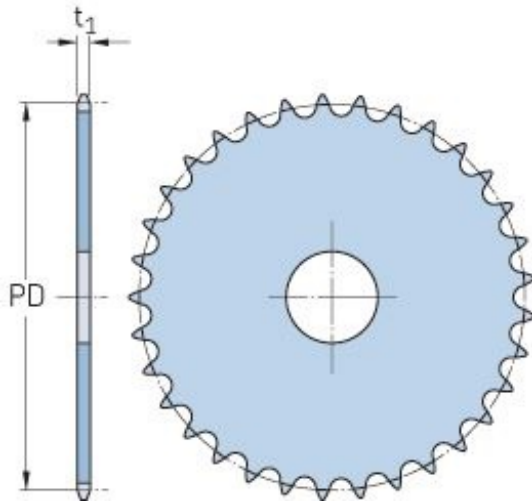

Pitch P (mm)	9.52
Pitch P (in)	0.37
No. of teeth	42
Pitch diameter (mm)	127.46
Pitch diameter (in)	5.02
Min. bore (mm)	-
Min. bore (in)	-
Max. bore (mm)	-
Max. bore (in)	-
Hub H (mm)	-
Hub H (in)	-
Hub L (mm)	-
Hub L (in)	-
Weight (kg)	0.48
Weight (lbs)	1.06