

# PHS 06B-1A80

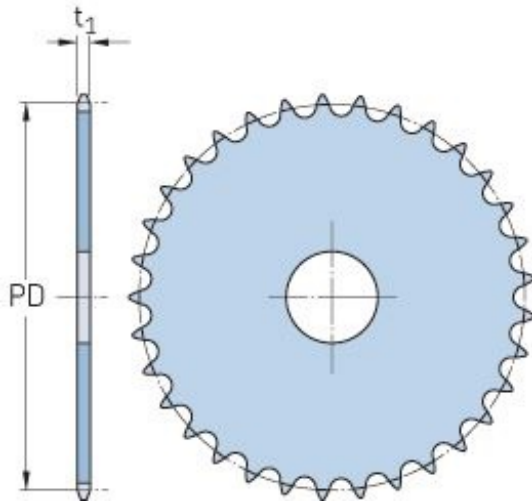

Pitch P (mm)	9.52
Pitch P (in)	0.37
No. of teeth	80
Pitch diameter (mm)	242.61
Pitch diameter (in)	9.55
Min. bore (mm)	-
Min. bore (in)	-
Max. bore (mm)	-
Max. bore (in)	-
Hub H (mm)	-
Hub H (in)	-
Hub L (mm)	-
Hub L (in)	-
Weight (kg)	1.53
Weight (lbs)	3.37