

PHS 08B-1B70

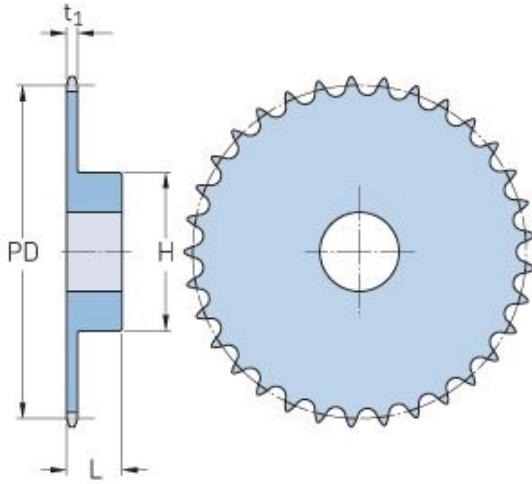

Pitch P (mm)	12.7
Pitch P (in)	0.5
No. of teeth	70
Pitch diameter (mm)	12.7
Pitch diameter (in)	0.5
Min. bore (mm)	16
Min. bore (in)	0.63
Max. bore (mm)	64
Max. bore (in)	2.52
Hub H (mm)	90
Hub H (in)	3.54
Hub L (mm)	40
Hub L (in)	1.57
Weight (kg)	3.8
Weight (lbs)	8.38