

PHS 08B-1A38

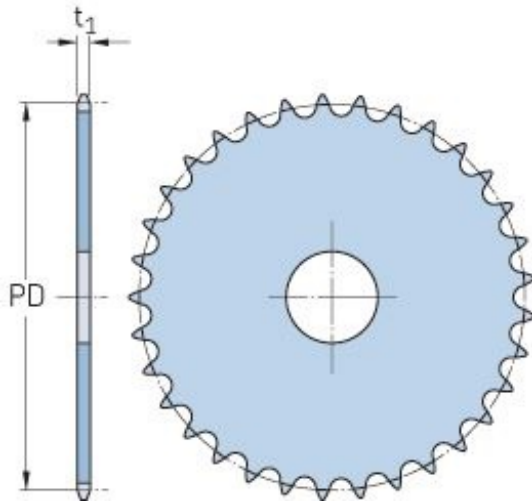

Pitch P (mm)	12.7
Pitch P (in)	0.5
No. of teeth	38
Pitch diameter (mm)	12.7
Pitch diameter (in)	0.5
Min. bore (mm)	-
Min. bore (in)	-
Max. bore (mm)	-
Max. bore (in)	-
Hub H (mm)	-
Hub H (in)	-
Hub L (mm)	-
Hub L (in)	-
Weight (kg)	0.97
Weight (lbs)	2.14