

PHS 10B-1B51

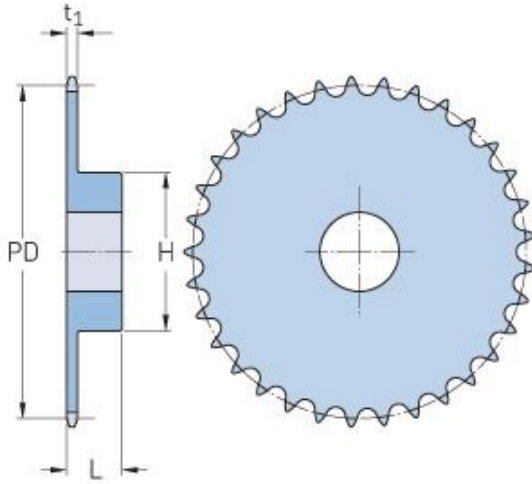

Pitch P (mm)	15.88
Pitch P (in)	0.63
No. of teeth	51
Pitch diameter (mm)	15.88
Pitch diameter (in)	0.63
Min. bore (mm)	20
Min. bore (in)	0.79
Max. bore (mm)	64
Max. bore (in)	2.52
Hub H (mm)	100
Hub H (in)	3.94
Hub L (mm)	40
Hub L (in)	1.57
Weight (kg)	5.14
Weight (lbs)	11.33