

PHS 12B-1B40

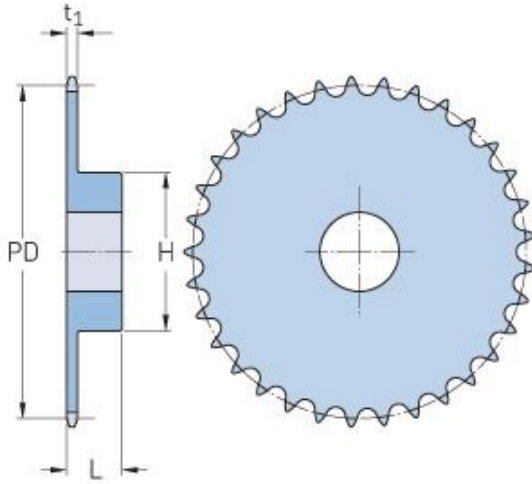

Pitch P (mm)	19.05
Pitch P (in)	0.75
No. of teeth	40
Pitch diameter (mm)	242.81
Pitch diameter (in)	9.56
Min. bore (mm)	20
Min. bore (in)	0.79
Max. bore (mm)	70
Max. bore (in)	2.76
Hub H (mm)	100
Hub H (in)	3.94
Hub L (mm)	40
Hub L (in)	1.57
Weight (kg)	5.54
Weight (lbs)	12.21