

PHS 12B-1B46

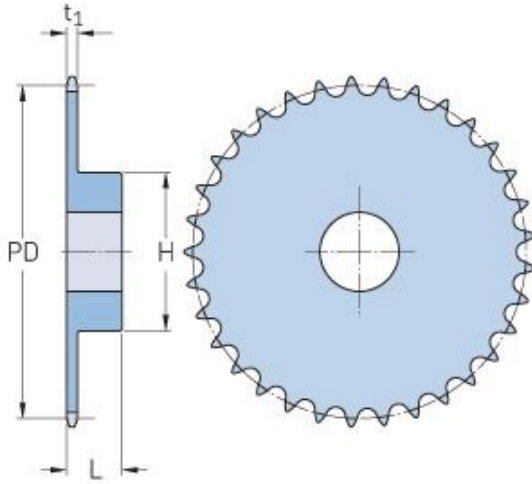

Pitch P (mm)	19.05
Pitch P (in)	0.75
No. of teeth	46
Pitch diameter (mm)	279.16
Pitch diameter (in)	10.99
Min. bore (mm)	20
Min. bore (in)	0.79
Max. bore (mm)	70
Max. bore (in)	2.76
Hub H (mm)	110
Hub H (in)	4.33
Hub L (mm)	56
Hub L (in)	2.2
Weight (kg)	6.98
Weight (lbs)	15.39