

PHS 12B-1B80

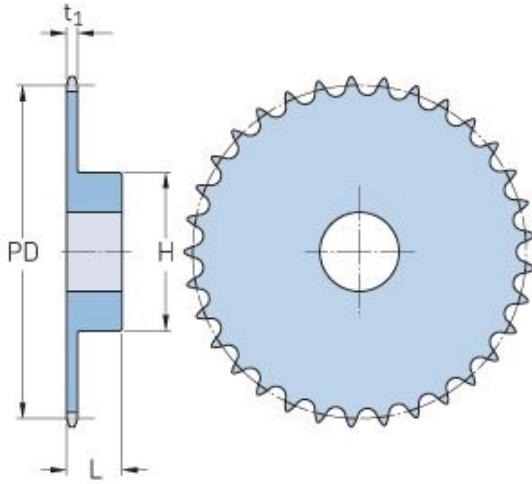

Pitch P (mm)	19.05
Pitch P (in)	0.75
No. of teeth	80
Pitch diameter (mm)	485.22
Pitch diameter (in)	19.1
Min. bore (mm)	20
Min. bore (in)	0.79
Max. bore (mm)	80
Max. bore (in)	3.15
Hub H (mm)	110
Hub H (in)	4.33
Hub L (mm)	56
Hub L (in)	2.2
Weight (kg)	15.14
Weight (lbs)	33.38