

# PHS 20B-1B30

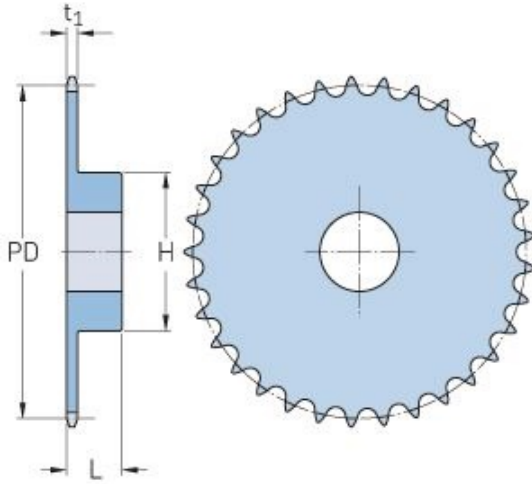

Pitch P (mm)	31.75
Pitch P (in)	1.25
No. of teeth	30
Pitch diameter (mm)	303.75
Pitch diameter (in)	11.96
Min. bore (mm)	25
Min. bore (in)	0.98
Max. bore (mm)	84
Max. bore (in)	3.31
Hub H (mm)	150
Hub H (in)	5.91
Hub L (mm)	55
Hub L (in)	2.17
Weight (kg)	12.02
Weight (lbs)	26.5