

PHE 1030TGHCOVER

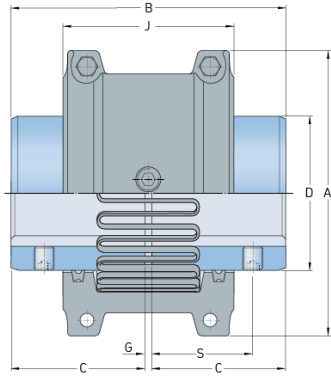

Size	1030
Nominal torque (lbft)	109.9
Nominal torque (Nm)	149
Min. bore (mm)	12
Max speed (r/min)	4500
Min. bore (in)	0.47
Max. bore (mm)	36
Max. bore (in)	1.42
Weight (kg)	0.57
Weight (lbs)	1.26