

PHE 1040TGHCOVER

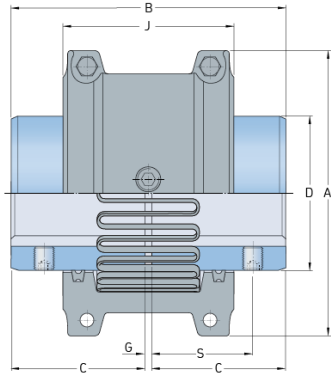

Size	1040
Nominal torque (lbft)	183.65
Nominal torque (Nm)	249
Min. bore (mm)	12
Max speed (r/min)	4500
Min. bore (in)	0.47
Max. bore (mm)	44
Max. bore (in)	1.73
Weight (kg)	0.58
Weight (lbs)	1.28