

PHE 1070TGHCOVER

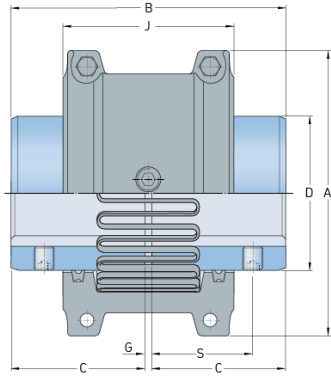

Size	1070
Nominal torque (lbft)	733.14
Nominal torque (Nm)	994
Min. bore (mm)	19
Max speed (r/min)	4125
Min. bore (in)	0.75
Max. bore (mm)	65
Max. bore (in)	2.56
Weight (kg)	1.45
Weight (lbs)	3.2