

PHE 1120TGHCOVER

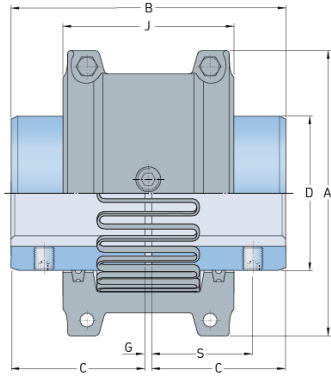

Size	1120
Nominal torque (lbft)	10104.6
Nominal torque (Nm)	13700
Min. bore (mm)	60
Max speed (r/min)	2025
Min. bore (in)	2.36
Max. bore (mm)	136
Max. bore (in)	5.35
Weight (kg)	8.6
Weight (lbs)	18.96