

PHE 1020TGGRID

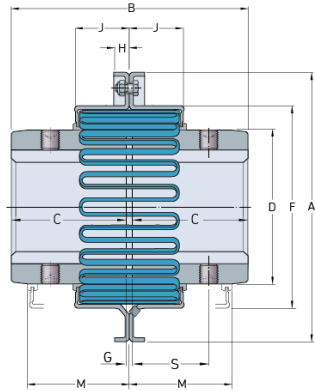

Size	1020
Nominal torque (lbft)	38.35
Nominal torque (Nm)	52
Min. bore (mm)	12
Max speed (r/min)	6000
Min. bore (in)	0.47
Max. bore (mm)	30
Max. bore (in)	1.18
Weight (kg)	0.08
Weight (lbs)	0.18