

PHE 1160TGGRID

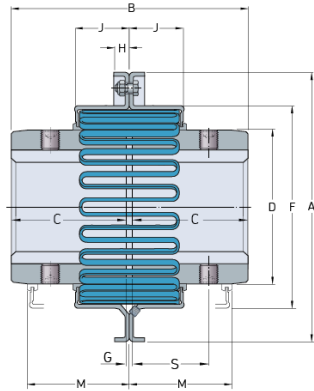

Size	1160
Nominal torque (lbft)	41229.72
Nominal torque (Nm)	55900
Min. bore (mm)	120
Max speed (r/min)	1750
Min. bore (in)	4.72
Max. bore (mm)	228
Max. bore (in)	8.98
Weight (kg)	0.2
Weight (lbs)	0.44