

PHE 1030TGRSB

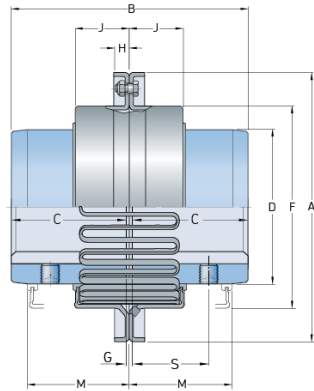

Size	1030
Nominal torque (lbft)	109.9
Nominal torque (Nm)	149
Min. bore (mm)	12
Max speed (r/min)	6000
Min. bore (in)	0.47
Max. bore (mm)	36
Max. bore (in)	1.42
Weight (kg)	0.83
Weight (lbs)	1.83