

PHE 1040TGRSB

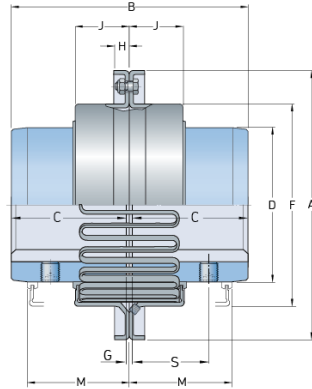

Size	1040
Nominal torque (lbft)	183.65
Nominal torque (Nm)	249
Min. bore (mm)	13
Max speed (r/min)	4500
Min. bore (in)	0.5
Max. bore (mm)	43
Max. bore (in)	1.69
Weight (kg)	1.17
Weight (lbs)	2.58