

PHE 1050TGRSB

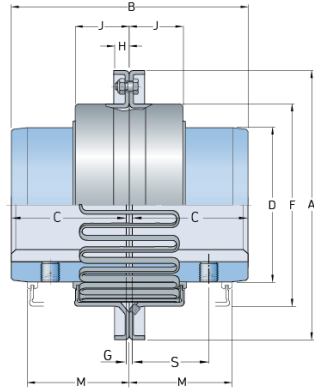

Size	1050
Nominal torque (lbft)	320.84
Nominal torque (Nm)	435
Min. bore (mm)	13
Max speed (r/min)	6000
Min. bore (in)	0.5
Max. bore (mm)	50
Max. bore (in)	1.97
Weight (kg)	1.95
Weight (lbs)	4.3