

PHE 1090TGRSB

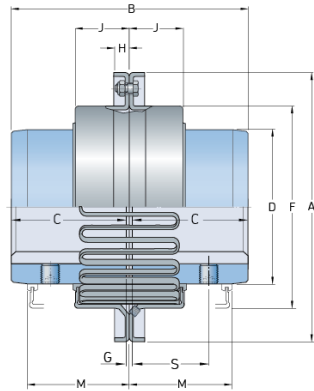

Size	1090
Nominal torque (lbft)	2751.11
Nominal torque (Nm)	3730
Min. bore (mm)	27
Max speed (r/min)	4000
Min. bore (in)	1.06
Max. bore (mm)	95
Max. bore (in)	3.74
Weight (kg)	10.4
Weight (lbs)	22.93