

# PHS 40-1AH13

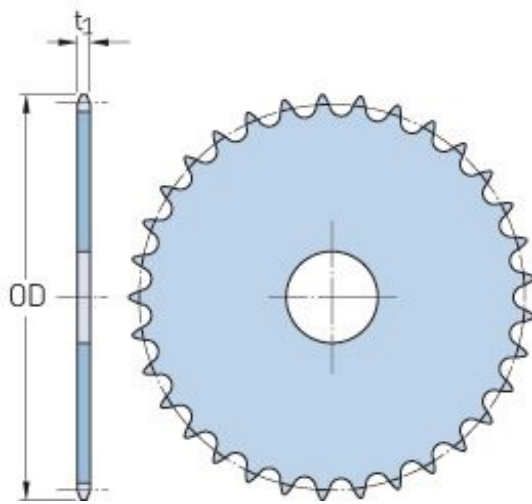

Pitch P (in)	0.5
No. of teeth	13
Diameter (in)	2.33
Min. bore (in)	-
Max. bore (in)	-
Hub H (in)	-
Hub L (in)	-
Weight (lbs)	-