

# PHS 40-1AH55

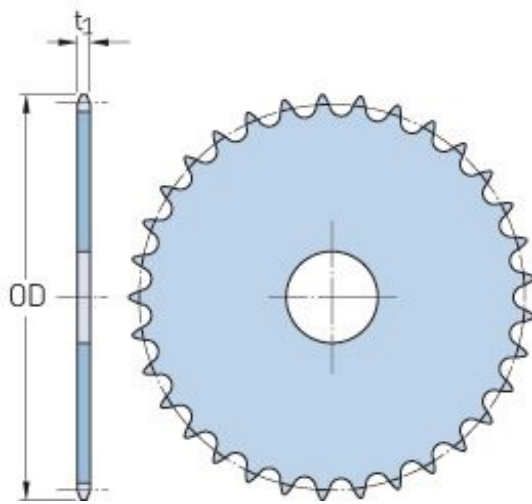

Pitch P (in)	0.5
No. of teeth	55
Diameter (in)	9.04
Min. bore (in)	-
Max. bore (in)	-
Hub H (in)	-
Hub L (in)	-
Weight (lbs)	-