

PHS 60-1AH21

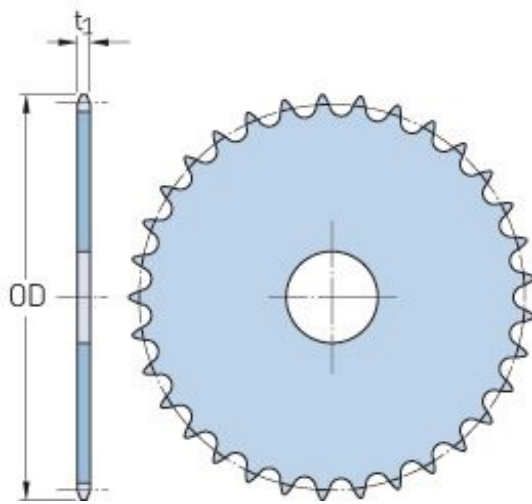

Pitch P (in)	0.75
No. of teeth	21
Diameter (in)	5.43
Min. bore (in)	-
Max. bore (in)	-
Hub H (in)	-
Hub L (in)	-
Weight (lbs)	-