

PHS 100-1BH17

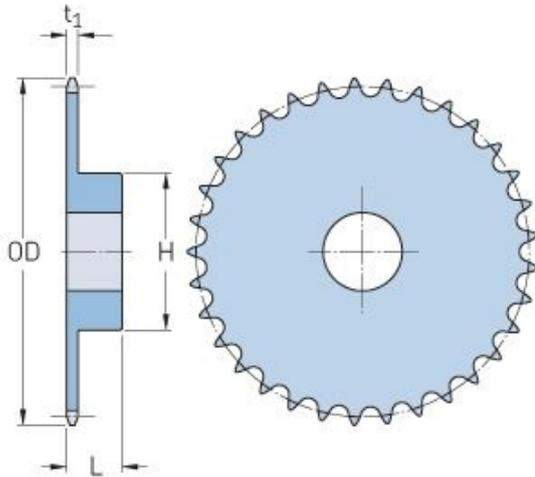

Pitch P (in)	1.25
No. of teeth	17
Diameter (in)	7.44
Min. bore (in)	1.31
Max. bore (in)	3
Hub H (in)	4.5
Hub L (in)	1.75
Weight (lbs)	-