

PHS 06B-1BH40

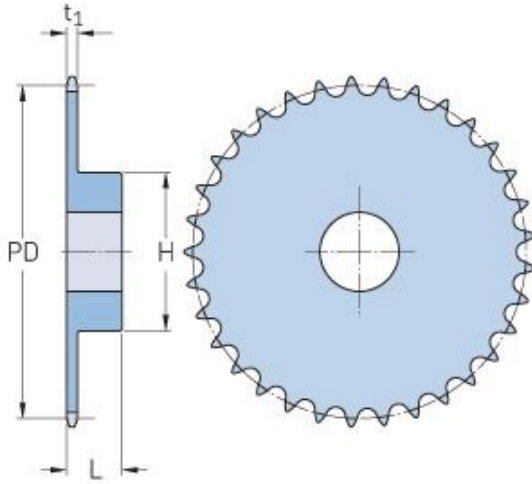

Pitch P (mm)	9.52
Pitch P (in)	0.37
No. of teeth	40
Pitch diameter (mm)	121.4
Pitch diameter (in)	4.78
Min. bore (mm)	14
Min. bore (in)	0.55
Max. bore (mm)	48
Max. bore (in)	1.89
Hub H (mm)	70
Hub H (in)	2.76
Hub L (mm)	30
Hub L (in)	1.18
Weight (kg)	1.16
Weight (lbs)	2.56