

PHS 08B-1BH28

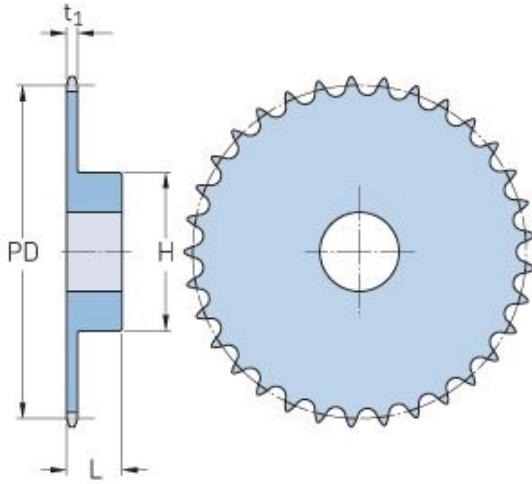

Pitch P (mm)	12.7
Pitch P (in)	0.5
No. of teeth	28
Pitch diameter (mm)	12.7
Pitch diameter (in)	0.5
Min. bore (mm)	16
Min. bore (in)	0.63
Max. bore (mm)	46
Max. bore (in)	1.81
Hub H (mm)	70
Hub H (in)	2.76
Hub L (mm)	30
Hub L (in)	1.18
Weight (kg)	1.17
Weight (lbs)	2.58