

# PHS 08B-1BH95

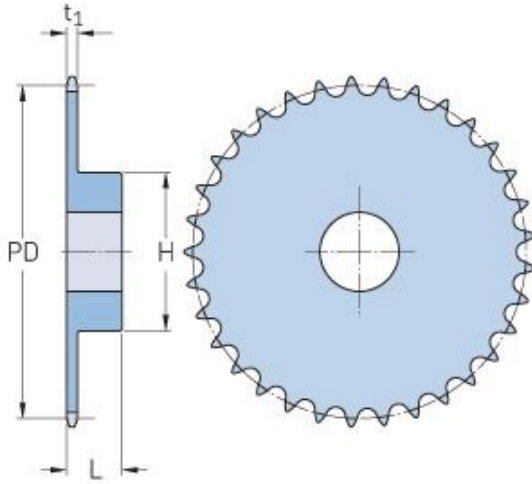

Pitch P (mm)	12.7
Pitch P (in)	0.5
No. of teeth	95
Pitch diameter (mm)	12.7
Pitch diameter (in)	0.5
Min. bore (mm)	16
Min. bore (in)	0.63
Max. bore (mm)	55
Max. bore (in)	2.17
Hub H (mm)	90
Hub H (in)	3.54
Hub L (mm)	40
Hub L (in)	1.57
Weight (kg)	7.38
Weight (lbs)	16.27