

# PHS 12B-1BH20

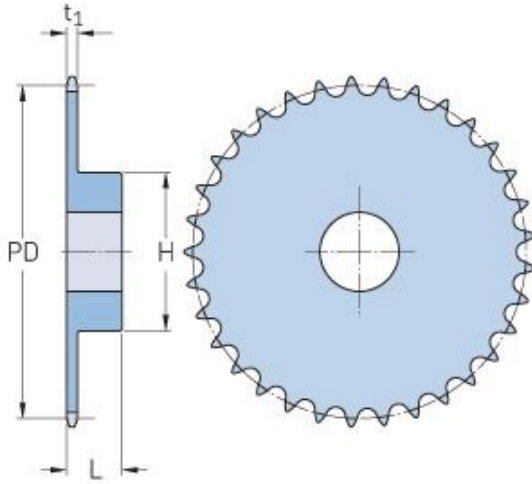

Pitch P (mm)	19.05
Pitch P (in)	0.75
No. of teeth	20
Pitch diameter (mm)	121.78
Pitch diameter (in)	4.79
Min. bore (mm)	16
Min. bore (in)	0.63
Max. bore (mm)	55
Max. bore (in)	2.17
Hub H (mm)	80
Hub H (in)	3.15
Hub L (mm)	35
Hub L (in)	1.38
Weight (kg)	1.83
Weight (lbs)	4.03