

PHS 12B-1BH33

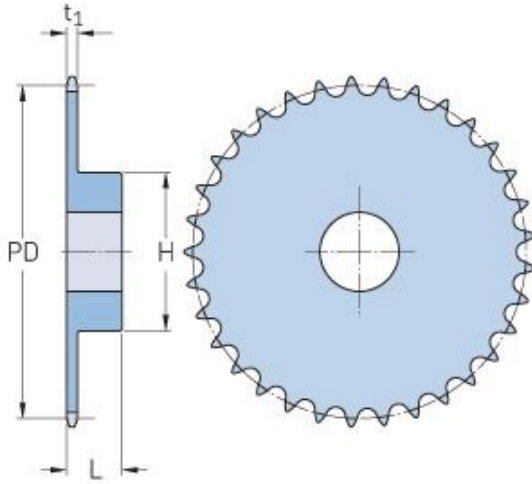

Pitch P (mm)	19.05
Pitch P (in)	0.75
No. of teeth	33
Pitch diameter (mm)	200.4
Pitch diameter (in)	7.89
Min. bore (mm)	20
Min. bore (in)	0.79
Max. bore (mm)	64
Max. bore (in)	2.52
Hub H (mm)	95
Hub H (in)	3.74
Hub L (mm)	40
Hub L (in)	1.57
Weight (kg)	4.28
Weight (lbs)	9.44