

# PHS 20B-1BH10

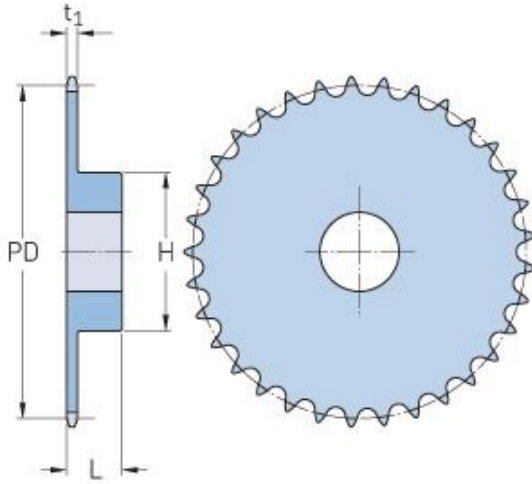

Pitch P (mm)	31.75
Pitch P (in)	1.25
No. of teeth	10
Pitch diameter (mm)	102.75
Pitch diameter (in)	4.05
Min. bore (mm)	20
Min. bore (in)	0.79
Max. bore (mm)	60
Max. bore (in)	2.36
Hub H (mm)	70
Hub H (in)	2.76
Hub L (mm)	40
Hub L (in)	1.57
Weight (kg)	1.86
Weight (lbs)	4.1