

# PHC 50-1C/L

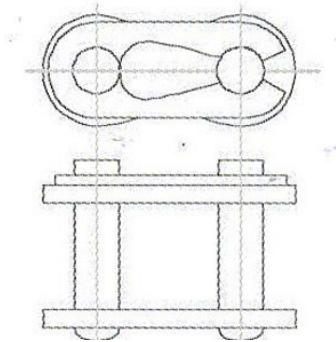

Type of link	C/L
--------------	-----