

PHF FX20-8X15

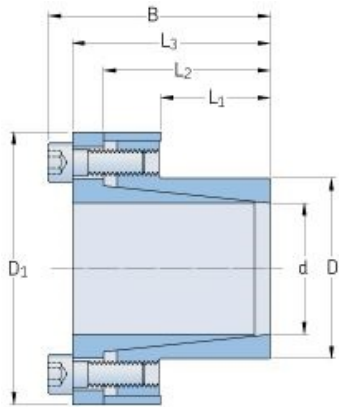

Bushing no.	FX20
d (mm)	8
d (in)	0.31
D (mm)	15
d_w (mm)	-
L (mm)	-
L_1 (mm)	12
L_2 (mm)	22
L_3 (mm)	25
B (mm)	29
D_1 (mm)	27
d_1 (mm)	-
e (mm)	-
F_t Transmissible axial force (kN)	6.65
M_t Transmissible torque (Nm)	25
P_w Shaft surface pressure (N/mm ²)	210
P_n Hub surface pressure (N/mm ²)	110
Clamp screws Qty	3
Clamp screws size	M4
Clamp screws nut	-
M_s Screw tightening torque (Nm)	4.9
Weight (kg)	0.05