

PHF FX20-19X27

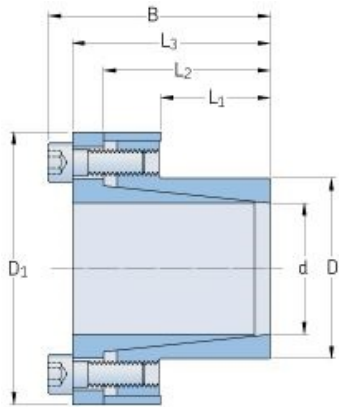

Bushing no.	FX20
d (mm)	19
d (in)	0.75
D (mm)	27
d_w (mm)	-
L (mm)	-
L_1 (mm)	18
L_2 (mm)	31
L_3 (mm)	38
B (mm)	44
D_1 (mm)	49
d_1 (mm)	-
e (mm)	-
F_t Transmissible axial force (kN)	22
M_t Transmissible torque (Nm)	210
P_w Shaft surface pressure (N/mm ²)	170
P_n Hub surface pressure (N/mm ²)	120
Clamp screws Qty	4
Clamp screws size	M6
Clamp screws nut	-
M_s Screw tightening torque (Nm)	17
Weight (kg)	0.26